



Marmotest s.r.l.
Via Brigade Partigiane n. 47
fax +390187 968633 cell +393425343505
info@marmotest.com



number 1273310

TEST REPORT

LFD018C99

ASTM C99- STANDARD TEST METHOD FOR MODULUS OF RUPTURE OF DIMENSION STONE

CLIENT	Namibia Marble and Granite (Pty) Ltd. P.O.Box 69 Karibib Namibia Tel +264 64 550201 (W)
PETROGRAPHIC NAME [ASTM C119]	Marble
TRADE NAME	White Rhino
SPECIMEN QUANTITIES	5 DRY 5 WET
SUMMARY OF TEST	MODULUS OF RUPTURE DRY: 10,7 MPa [1548 psi] WET: 8,2 MPa [1194 psi]
MINIMUM VALUE REQUIRED (ASTM C503 Standard Specification for Marble Dimension Stone)	6,9 MPa [1000 psi]

Test results dry page 1

Test results wet page 7

Carrara - January 25, 2019

Apparatus



The testing machine is a "servocontrolled"

machine, controlled by a real time digital platform

C-Rio with FPGA technology.

The load is measured by a TCE load cell (5511 lbf of nominal load - linearity < 0.03%; hysteresis < 0.03%; repeatability < 0.01%).

Load cell data acquisition (A/D) is performed by National Instruments NI 9237 24-Bit module. Sample frequency is 10 milliseconds.

The support for the specimens are of the rocker type while the load application block are installed on a special bearing which ensure that forces is applied without eccentricity.

The surfaces in contact with the specimen, both in the support block and in the load one, are chromed steel rods with a nominal diameter of 1 in.

Measuring instruments

Specimen size has been measured by a digital caliber "Mitutoyo Absolute" model CD-15PKX (serial no. 13185236) with a precision of 0.01 mm (0.39 mil). Measurements have been made using the international system of units (SI).

Conditioning

Dry conditions - before testing the specimens have been conditioned for 49 h at $140^{\circ}\text{F} \pm 4^{\circ}\text{F}$ [60 ± 2] $^{\circ}\text{C}$. The temperature in the climatic chamber is controlled by a West 6500 temperature controller with PID logical and a PT100 temperature sensor. After dry periods the specimens are kept at room temperature in a desiccator. Wet conditions - before testing the specimens have been conditioned for 48 h in water at $72^{\circ}\text{F} \pm 4^{\circ}\text{F}$ [22 ± 2] $^{\circ}\text{C}$.

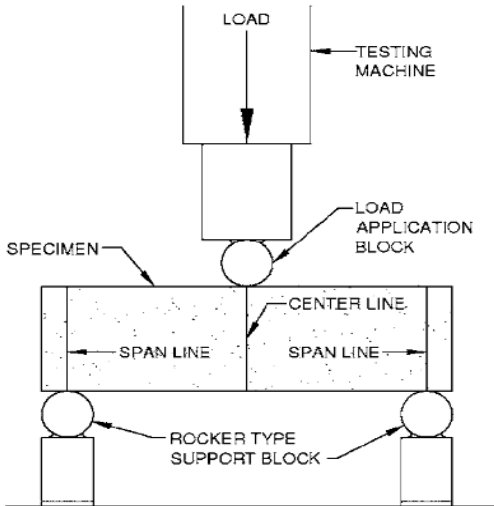

Span = 180 mm

Modulus of rupture:

$$R = \frac{3 * F * L}{2 * b * d^2}$$

Load gradient

Loading gradient is kept under 1000 psi/min [5000 N/min] until specimen failure.

*The laboratory technician
 dott. Gabriele Pinelli*

Marmo Test s.a.s.
 di DAVIDE ROCCA & C.
 Via Brigade Partigiane, 47
 54033 Carrara (MS)
 P. IVA 01163160458



Marmotest s.r.l.

Via Brigade Partigiane n. 47
 Nazzano Avenza (MS)
 tel/fax n. +39.0187.968633 mob +39.342.5343505
 skype: marmotest
info@marmotest.com



membership number
1273310

C 99 **DRY** **Vein: N/A**

Number of specimens 5
Date of conditioning 17/12/2018
Date of measurement 20/12/2018
Date of test 20/12/2018

Conditioning operator 8
Measurement operator 8
Test operator 8

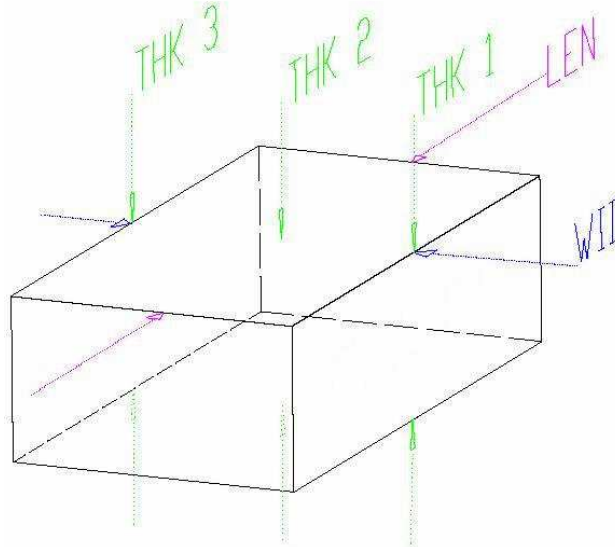

Name	LEN [in]	THK1 [in]	THK2 [in]	THK3 [in]	THK AVG [in]	WID [in]	BRK LOAD [lbf]	DEFL [mil]	SPAN [in]	R [psi]
LFD018C99D_01	7,87	2,46	2,46	2,46	2,46	3,94	2.205	0,00	7,0	981
LFD018C99D_02	7,87	2,46	2,46	2,45	2,46	3,93	4.729	0,00	7,0	2.119
LFD018C99D_03	7,87	2,46	2,46	2,46	2,46	3,93	2.641	0,00	7,0	1.178
LFD018C99D_04	7,87	2,48	2,47	2,46	2,47	3,95	3.272	0,00	7,0	1.442
LFD018C99D_05	7,87	2,47	2,47	2,46	2,47	3,95	3.280	0,00	7,0	1.450

R average 1.547 psi **R std. dev.** 402 psi

Name	LEN [mm]	THK1 [mm]	THK2 [mm]	THK3 [mm]	THK AVG [mm]	WID [mm]	BRK LOAD [N]	DEFL [mm]	SPAN [mm]	R [MPa]
LFD018C99D_01	200,00	62,59	62,53	62,48	62,53	100,07	9.810	0,00	180,00	6,77
LFD018C99D_02	200,00	62,56	62,39	62,20	62,38	99,89	21.042	0,00	180,00	14,62
LFD018C99D_03	200,00	62,55	62,55	62,50	62,53	99,88	11.752	0,00	180,00	8,12
LFD018C99D_04	200,00	62,98	62,79	62,58	62,78	100,23	14.558	0,00	180,00	9,95
LFD018C99D_05	200,00	62,84	62,68	62,53	62,68	100,33	14.597	0,00	180,00	10,00

R average 10,67 MPa **R std. dev.** 2,77 MPa

NOTES

Specimen LFD018C99D_01 is a faulty test piece due to a fissure.
 It gives a value of as much as 20% under the average and so it is excluded from the list

Specimen LFD018C99D_01 test result



LFD018C99D_01 Deflection - Load graph

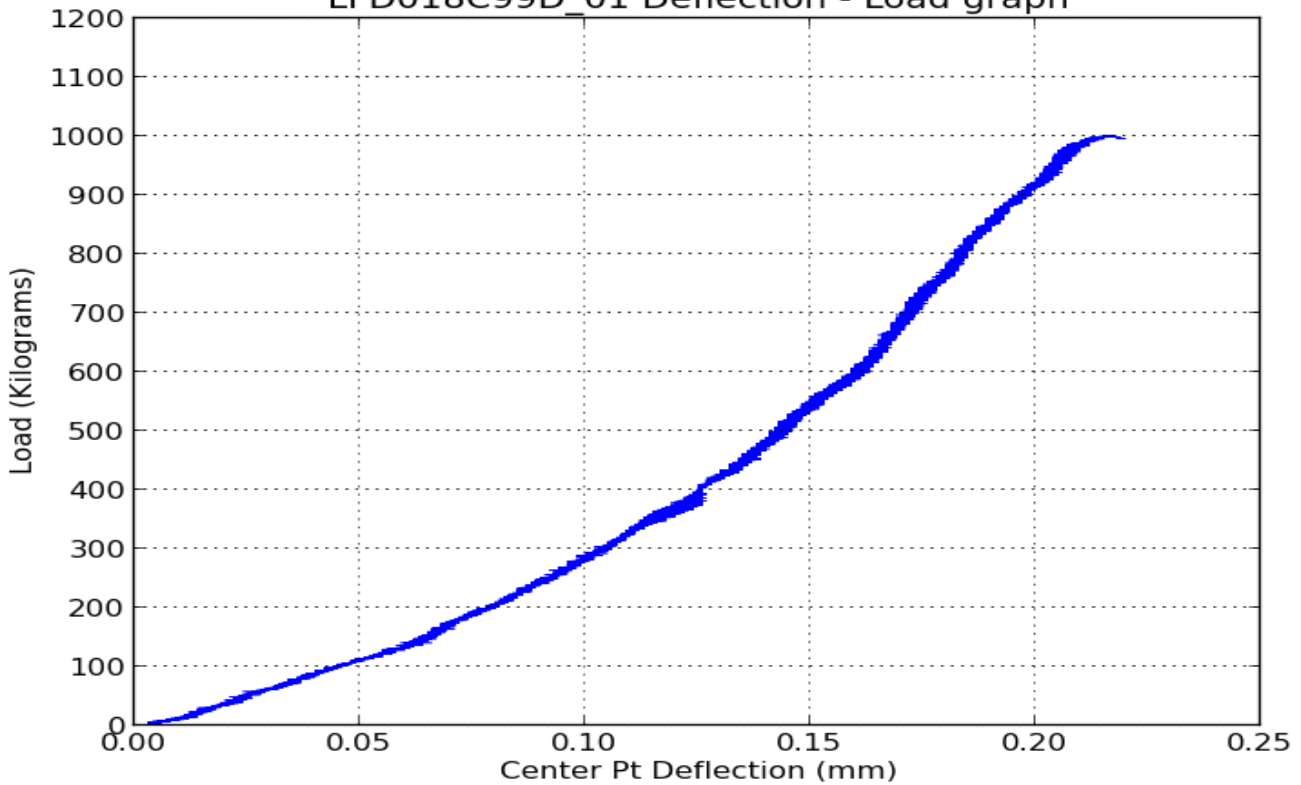

Name	LEN [in]	THK1 [in]	THK2 [in]	THK3 [in]	THK AVG [in]	WID [in]	BRK LOAD [lbf]	DEFL [mil]	SPAN [in]	R [psi]
LFD018C99D_01	7,87	2,46	2,46	2,46	2,46	3,94	2.205	0,00	7,0	981

Name	LEN [mm]	THK1 [mm]	THK2 [mm]	THK3 [mm]	THK AVG [mm]	WID [mm]	LOAD [Kg]	LOAD [N]	DEFL [mm]	SPAN [mm]	R [MPa]
LFD018C99D_01	200,00	62,59	62,53	62,48	62,53	100,07	1.000	9.810	0,00	180,00	6,77

Specimen LFD018C99D_02 test result

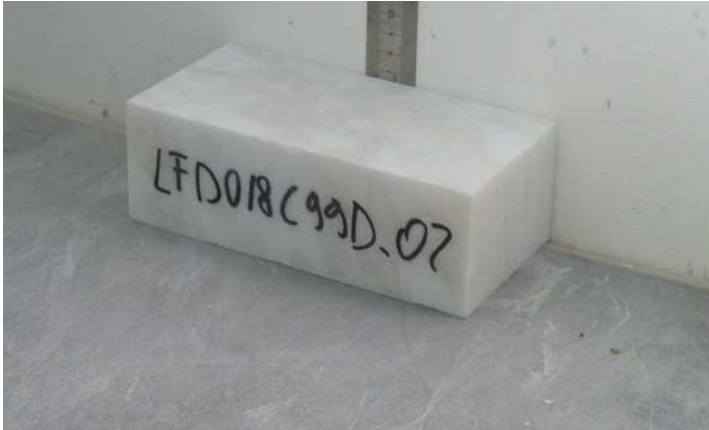

LFD018C99D_02 Deflection - Load graph

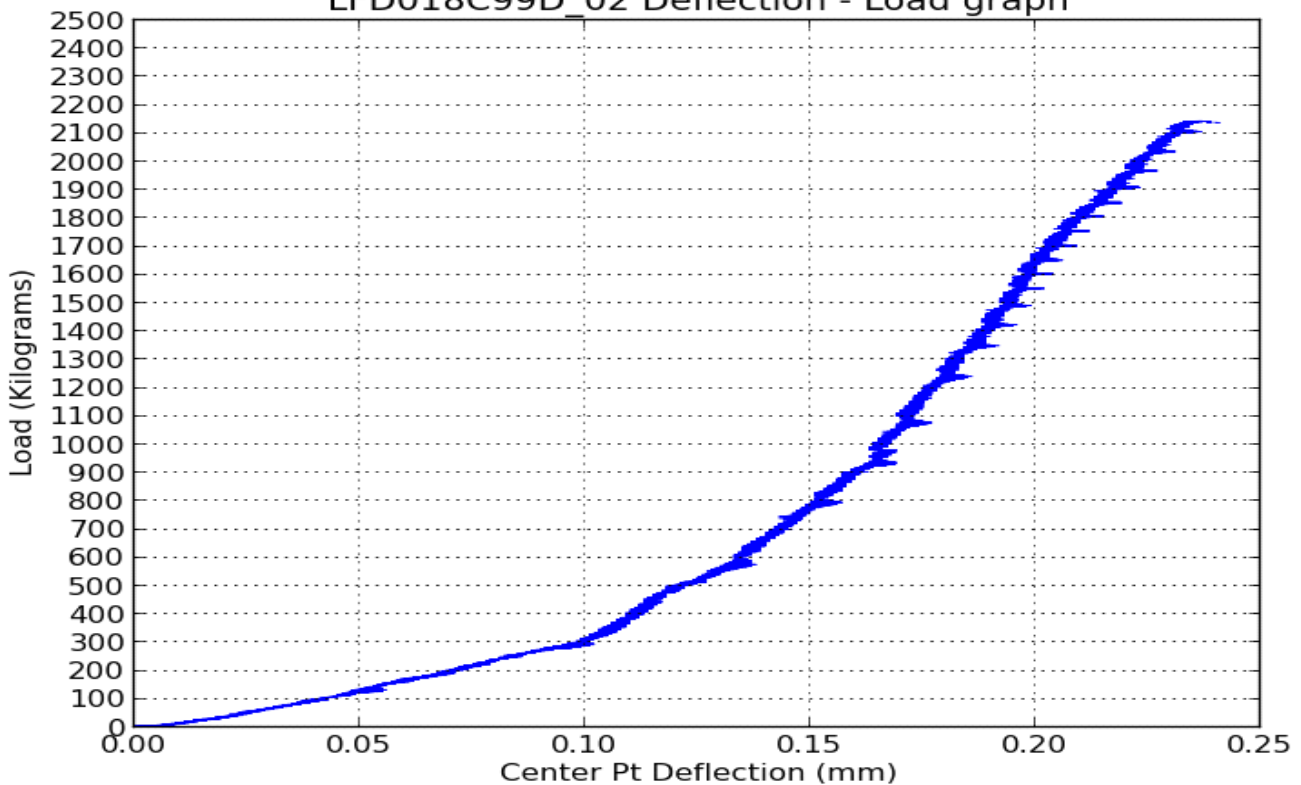

Name	LEN [in]	THK1 [in]	THK2 [in]	THK3 [in]	THK AVG [in]	WID [in]	BRK LOAD [lbf]	DEFL [mil]	SPAN [in]	R [psi]
LFD018C99D_02	7,87	2,46	2,46	2,45	2,46	3,93	4.729	0,00	7,0	2.119

Name	LEN [mm]	THK1 [mm]	THK2 [mm]	THK3 [mm]	THK AVG [mm]	WID [mm]	LOAD [Kg]	LOAD [N]	DEFL [mm]	SPAN [mm]	R [MPa]
LFD018C99D_02	200,00	62,56	62,39	62,20	62,38	99,89	2.145	21.042	0,00	180,00	14,62

Specimen LFD018C99D_03 test result

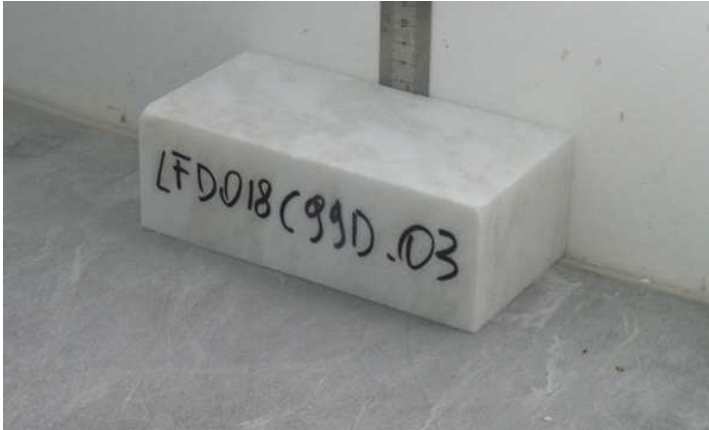

LFD018C99D_03 Deflection - Load graph

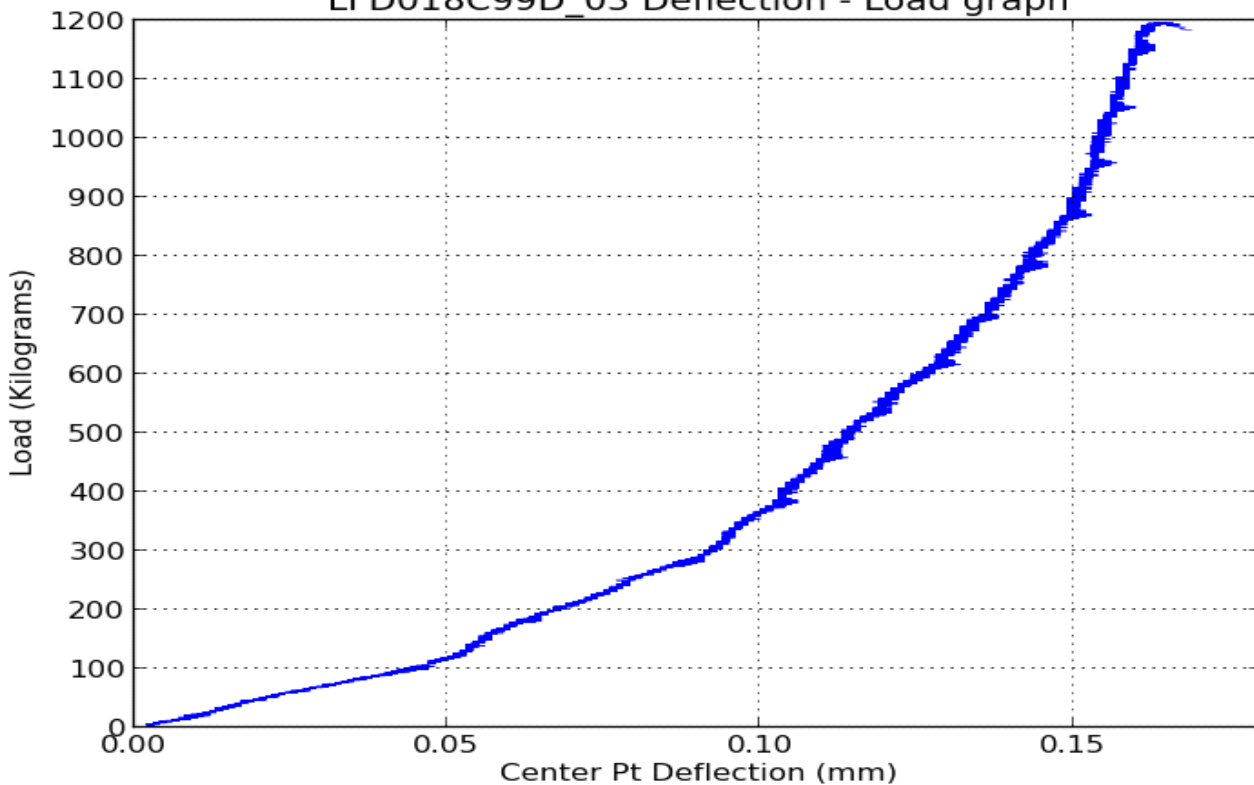

Name	LEN [in]	THK1 [in]	THK2 [in]	THK3 [in]	THK AVG [in]	WID [in]	BRK LOAD [lbf]	DEFL [mil]	SPAN [in]	R [psi]
LFD018C99D_03	7,87	2,46	2,46	2,46	2,46	3,93	2.641	0,00	7,0	1.178

Name	LEN [mm]	THK1 [mm]	THK2 [mm]	THK3 [mm]	THK AVG [mm]	WID [mm]	LOAD [Kg]	LOAD [N]	DEFL [mm]	SPAN [mm]	R [MPa]
LFD018C99D_03	200,00	62,55	62,55	62,50	62,53	99,88	1.198	11.752	0,00	180,00	8,12

Specimen LFD018C99D_04 test result



LFD018C99D_04 Deflection - Load graph

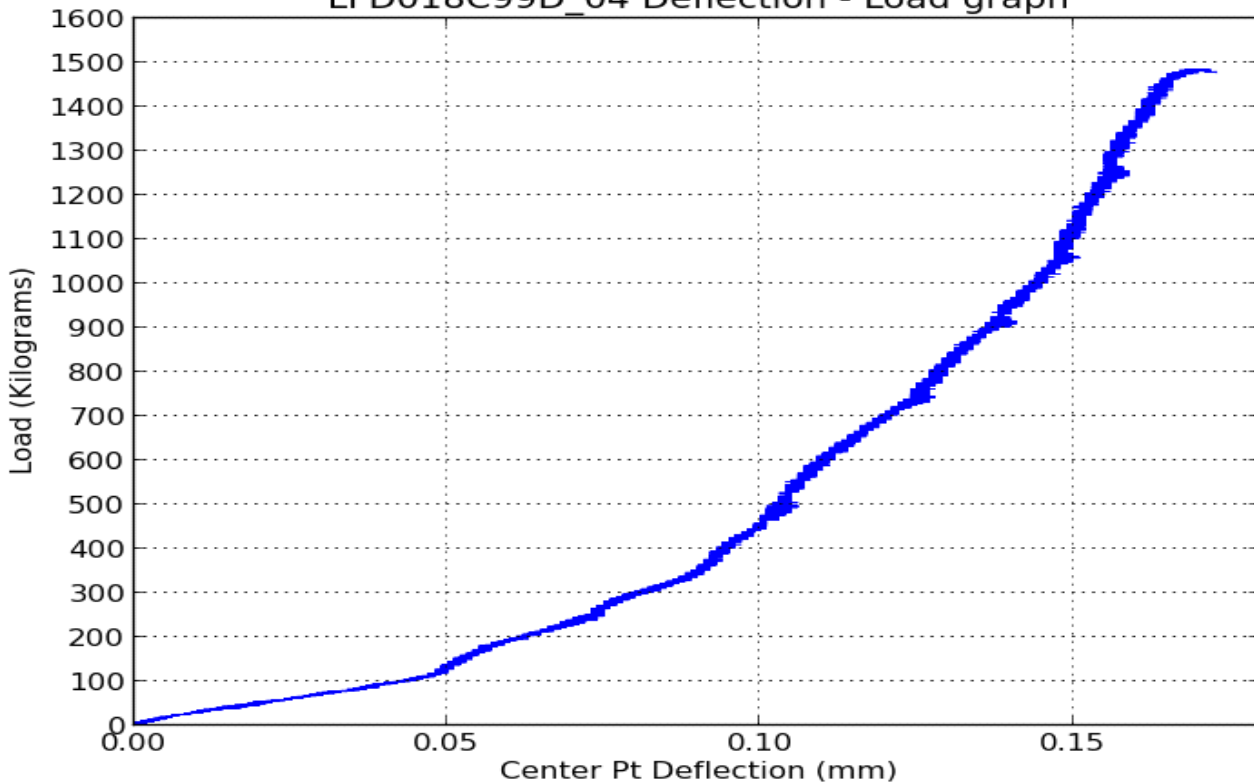

Name	LEN [in]	THK1 [in]	THK2 [in]	THK3 [in]	THK AVG [in]	WID [in]	BRK LOAD [lbf]	DEFL [mil]	SPAN [in]	R [psi]
LFD018C99D_04	7,87	2,48	2,47	2,46	2,47	3,95	3.272	0,00	7,0	1.442

Name	LEN [mm]	THK1 [mm]	THK2 [mm]	THK3 [mm]	THK AVG [mm]	WID [mm]	LOAD [Kg]	LOAD [N]	DEFL [mm]	SPAN [mm]	R [MPa]
LFD018C99D_04	200,00	62,98	62,79	62,58	62,78	100,23	1.484	14.558	0,00	180,00	9,95

Specimen LFD018C99D_05 test result



LFD018C99D_05 Deflection - Load graph

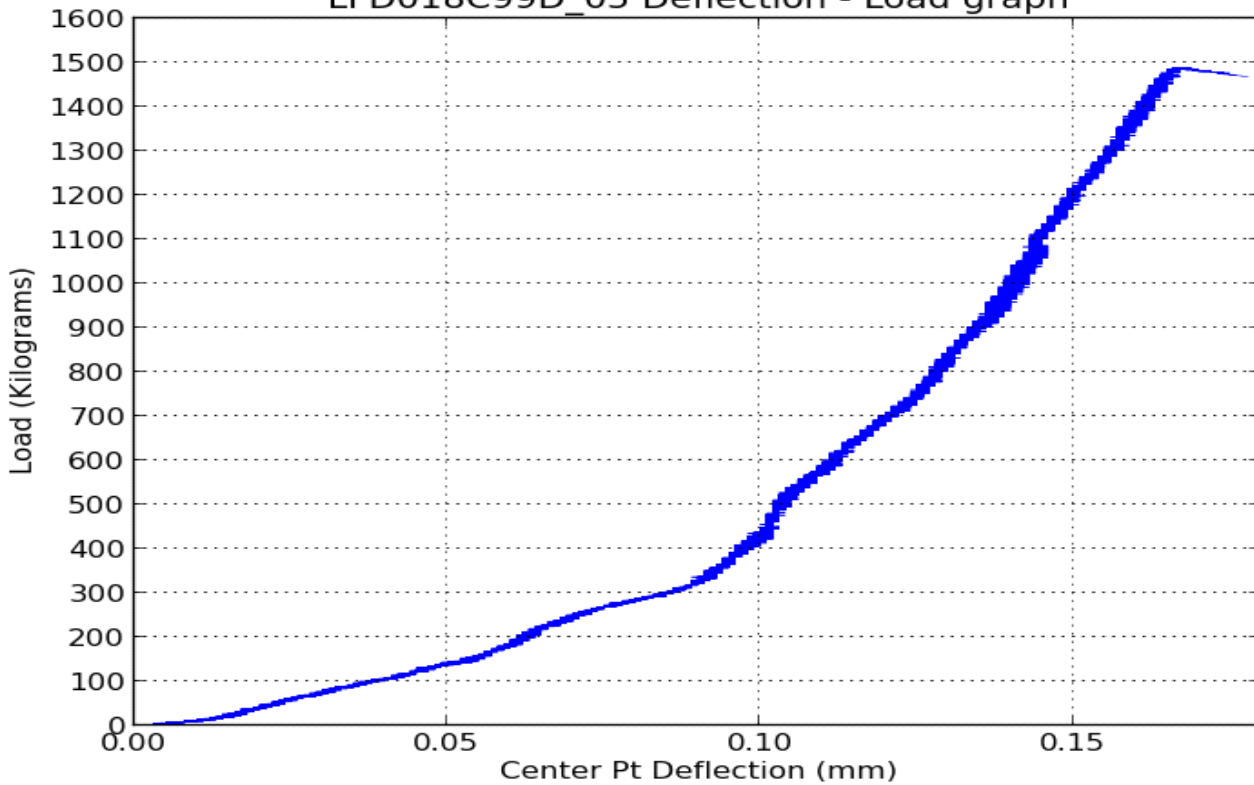

Name	LEN [in]	THK1 [in]	THK2 [in]	THK3 [in]	THK AVG [in]	WID [in]	BRK LOAD [lbf]	DEFL [mil]	SPAN [in]	R [psi]
LFD018C99D_05	7,87	2,47	2,47	2,46	2,47	3,95	3.280	0,00	7,0	1.450

Name	LEN [mm]	THK1 [mm]	THK2 [mm]	THK3 [mm]	THK AVG [mm]	WID [mm]	LOAD [Kg]	LOAD [N]	DEFL [mm]	SPAN [mm]	R [MPa]
LFD018C99D_05	200,00	62,84	62,68	62,53	62,68	100,33	1.488	14.597	0,00	180,00	10,00

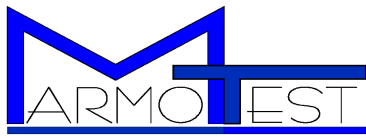

Marmotest s.r.l.

Via Brigate Partigiane n. 47
 Nazzano Avenza (MS)
 tel/fax n. +39.0187.968633 mob +39.342.5343505
 skype: marmotest
info@marmotest.com



membership number
1273310

C 99 **WET** **Vein: N/A**

Number of specimens 5
Date of conditioning 17/12/2018
Date of measurement 20/12/2018
Date of test 20/12/2018

Conditioning operator 8
Measurement operator 8
Test operator 8

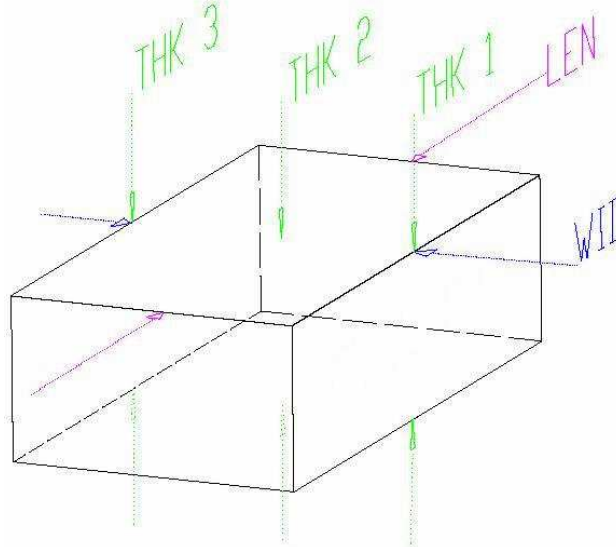

Name	LEN [in]	THK1 [in]	THK2 [in]	THK3 [in]	THK AVG [in]	WID [in]	BRK LOAD [lbf]	DEFL [mil]	SPAN [in]	R [psi]
LFD018C99W_01	7,87	2,49	2,48	2,48	2,48	3,94	2.809	0,00	7,0	1.228
LFD018C99W_02	7,87	2,46	2,46	2,45	2,46	3,94	2.242	0,00	7,0	1.004
LFD018C99W_03	7,87	2,46	2,46	2,47	2,46	3,94	3.534	0,00	7,0	1.571
LFD018C99W_04	7,87	2,48	2,48	2,49	2,48	3,94	2.765	0,00	7,0	1.207
LFD018C99W_05	7,87	2,45	2,46	2,46	2,46	3,94	2.149	0,00	7,0	959

R average 1.194 psi **R std. dev.** 243 psi

Name	LEN [mm]	THK1 [mm]	THK2 [mm]	THK3 [mm]	THK AVG [mm]	WID [mm]	BRK LOAD [N]	DEFL [mm]	SPAN [mm]	R [MPa]
LFD018C99W_01	200,00	63,21	63,11	63,01	63,11	100,01	12.498	0,00	180,00	8,47
LFD018C99W_02	200,00	62,48	62,38	62,25	62,37	100,02	9.977	0,00	180,00	6,92
LFD018C99W_03	200,00	62,49	62,56	62,64	62,56	100,08	15.725	0,00	180,00	10,84
LFD018C99W_04	200,00	63,09	63,10	63,13	63,11	100,18	12.302	0,00	180,00	8,33
LFD018C99W_05	200,00	62,32	62,46	62,57	62,45	100,11	9.565	0,00	180,00	6,61

R average 8,23 MPa **R std. dev.** 1,67 MPa

NOTES

Specimen LFD018C99W_01 test result

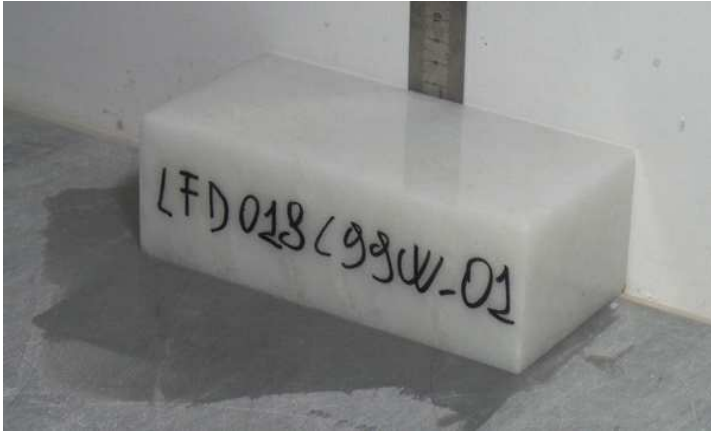

LFD018C99W_01 Deflection - Load graph

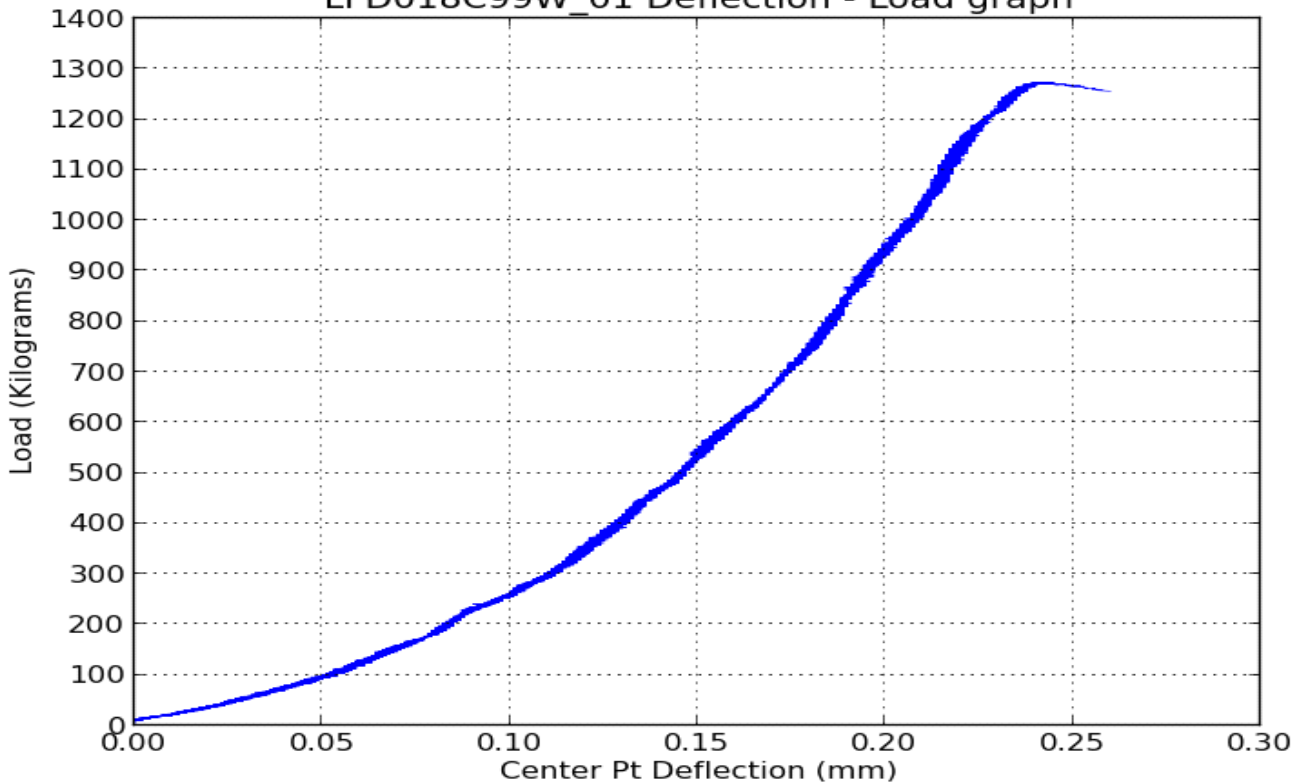

Name	LEN [in]	THK1 [in]	THK2 [in]	THK3 [in]	THK AVG [in]	WID [in]	BRK LOAD [lbf]	DEFL [mil]	SPAN [in]	R [psi]
LFD018C99W_01	7,87	2,49	2,48	2,48	2,48	3,94	2.809	0,00	7,0	1.228

Name	LEN [mm]	THK1 [mm]	THK2 [mm]	THK3 [mm]	THK AVG [mm]	WID [mm]	LOAD [Kg]	LOAD [N]	DEFL [mm]	SPAN [mm]	R [MPa]
LFD018C99W_01	200,00	63,21	63,11	63,01	63,11	100,01	1.274	12.498	0,00	180,00	8,47

Specimen LFD018C99W_02 test result

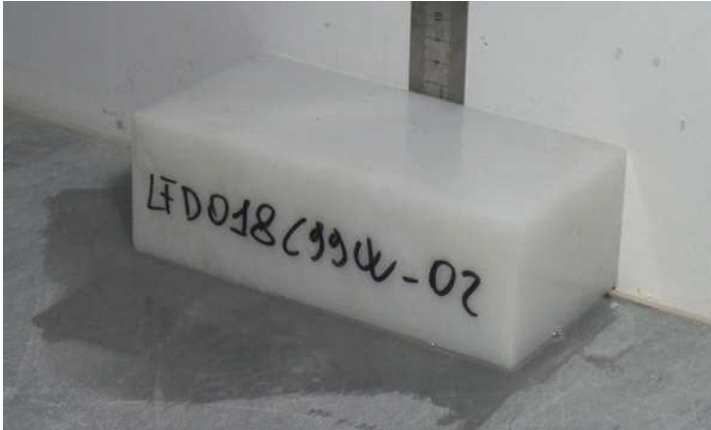

LFD018C99W_02 Deflection - Load graph

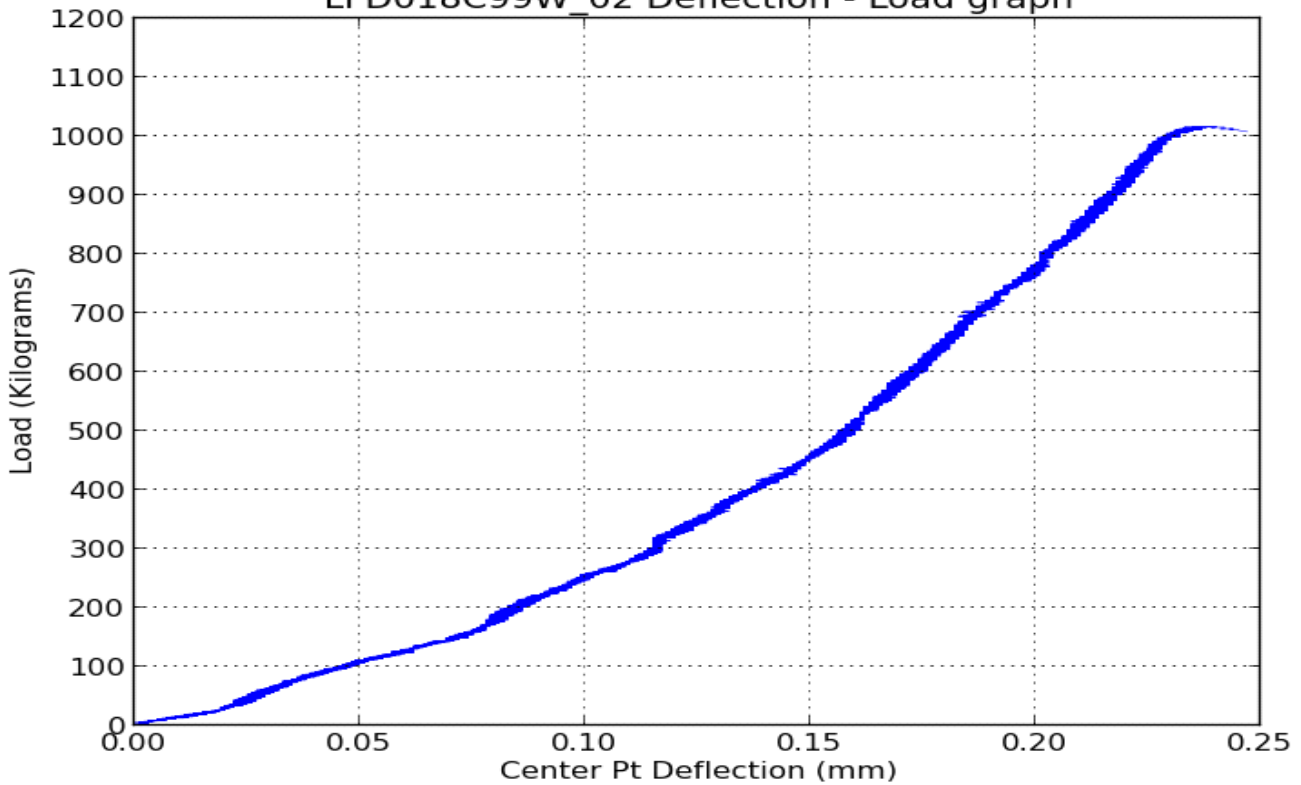

Name	LEN [in]	THK1 [in]	THK2 [in]	THK3 [in]	THK AVG [in]	WID [in]	BRK LOAD [lbf]	DEFL [mil]	SPAN [in]	R [psi]
LFD018C99W_02	7,87	2,46	2,46	2,45	2,46	3,94	2.242	0,00	7,0	1.004

Name	LEN [mm]	THK1 [mm]	THK2 [mm]	THK3 [mm]	THK AVG [mm]	WID [mm]	LOAD [Kg]	LOAD [N]	DEFL [mm]	SPAN [mm]	R [MPa]
LFD018C99W_02	200,00	62,48	62,38	62,25	62,37	100,02	1.017	9.977	0,00	180,00	6,92

Specimen LFD018C99W_03 test result

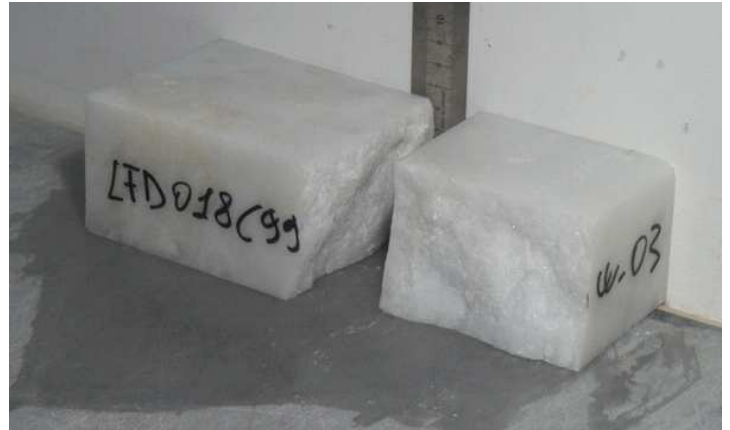

LFD018C99W_03 Deflection - Load graph

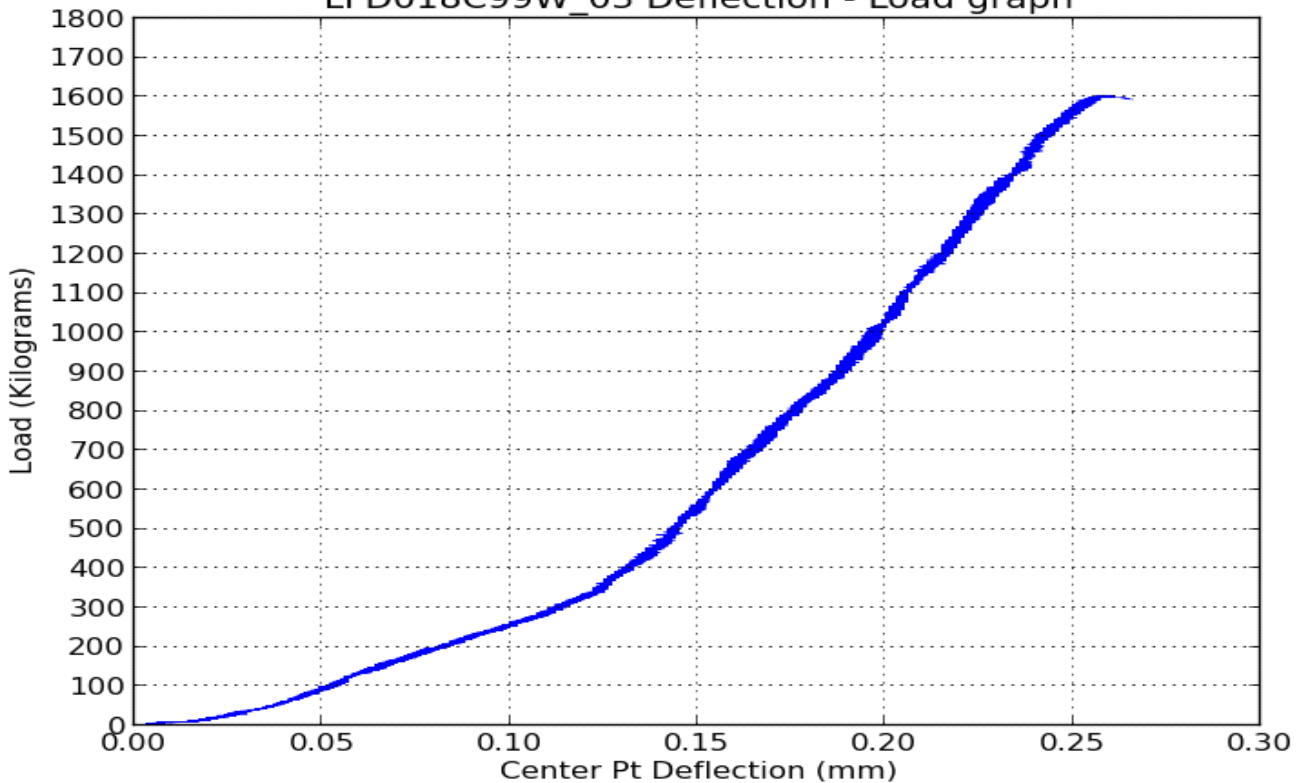

Name	LEN [in]	THK1 [in]	THK2 [in]	THK3 [in]	THK AVG [in]	WID [in]	BRK LOAD [lbf]	DEFL [mil]	SPAN [in]	R [psi]
LFD018C99W_03	7,87	2,46	2,46	2,47	2,46	3,94	3.534	0,00	7,0	1.571

Name	LEN [mm]	THK1 [mm]	THK2 [mm]	THK3 [mm]	THK AVG [mm]	WID [mm]	LOAD [Kg]	LOAD [N]	DEFL [mm]	SPAN [mm]	R [MPa]
LFD018C99W_03	200,00	62,49	62,56	62,64	62,56	100,08	1.603	15.725	0,00	180,00	10,84

Specimen LFD018C99W_04 test result



LFD018C99W_04 Deflection - Load graph

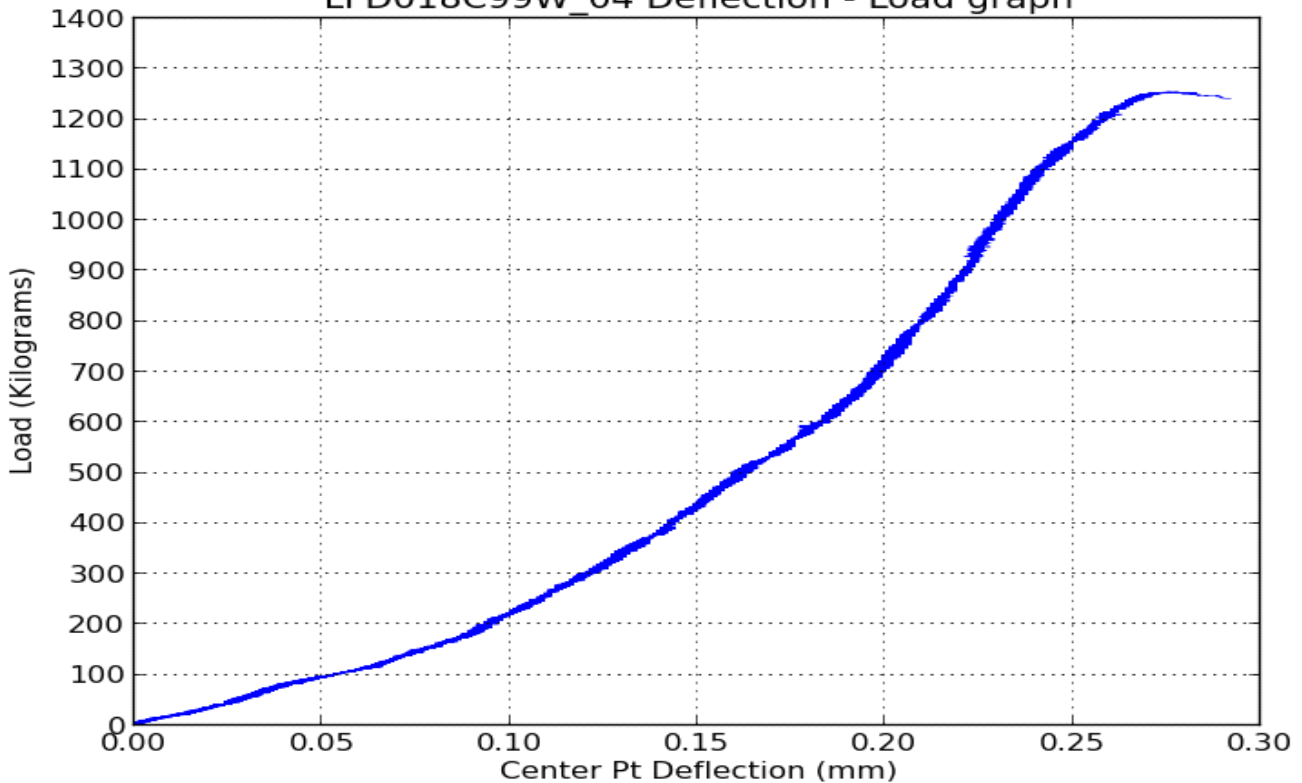

Name	LEN [in]	THK1 [in]	THK2 [in]	THK3 [in]	THK AVG [in]	WID [in]	BRK LOAD [lbf]	DEFL [mil]	SPAN [in]	R [psi]
LFD018C99W_04	7,87	2,48	2,48	2,49	2,48	3,94	2.765	0,00	7,0	1.207

Name	LEN [mm]	THK1 [mm]	THK2 [mm]	THK3 [mm]	THK AVG [mm]	WID [mm]	LOAD [Kg]	LOAD [N]	DEFL [mm]	SPAN [mm]	R [MPa]
LFD018C99W_04	200,00	63,09	63,10	63,13	63,11	100,18	1.254	12.302	0,00	180,00	8,33

Specimen LFD018C99W_05 test result



LFD018C99W_05 Deflection - Load graph

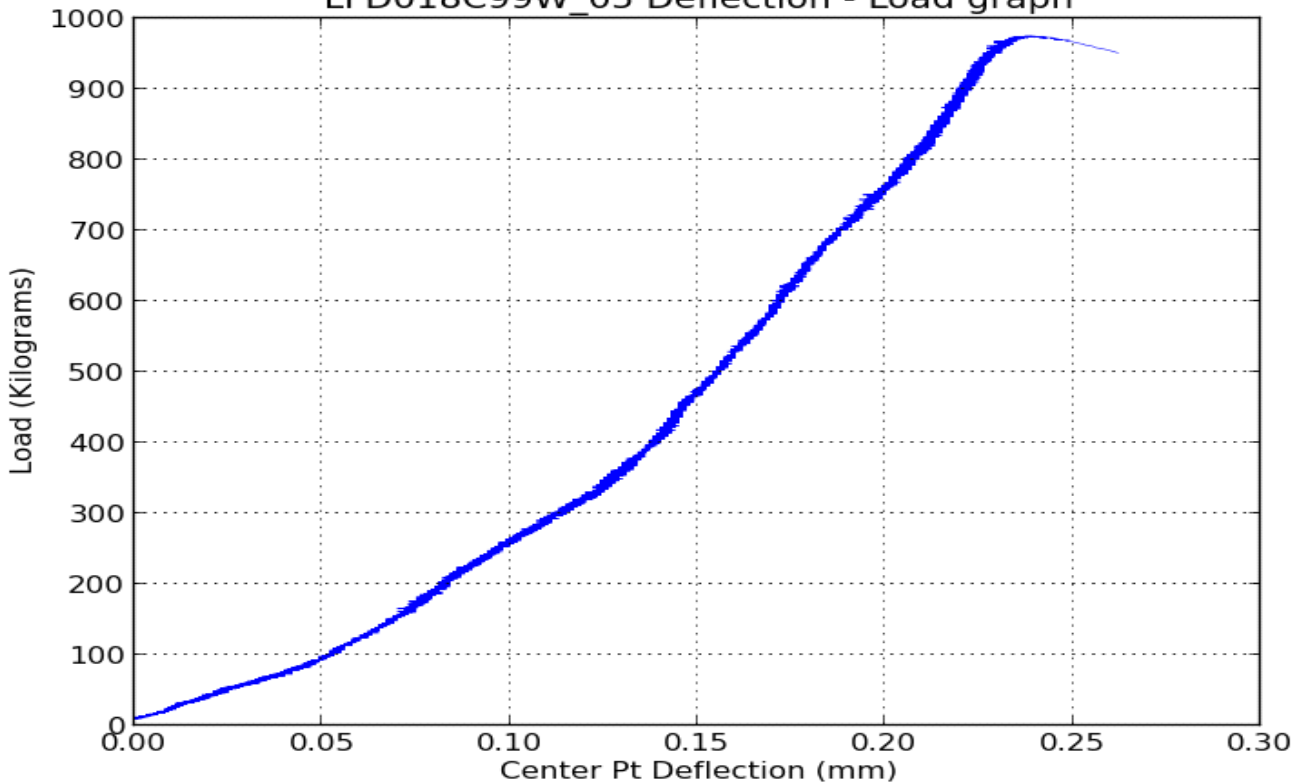

Name	LEN [in]	THK1 [in]	THK2 [in]	THK3 [in]	THK AVG [in]	WID [in]	BRK LOAD [lbf]	DEFL [mil]	SPAN [in]	R [psi]
LFD018C99W_05	7,87	2,45	2,46	2,46	2,46	3,94	2.149	0,00	7,0	959

Name	LEN [mm]	THK1 [mm]	THK2 [mm]	THK3 [mm]	THK AVG [mm]	WID [mm]	LOAD [Kg]	LOAD [N]	DEFL [mm]	SPAN [mm]	R [MPa]
LFD018C99W_05	200,00	62,32	62,46	62,57	62,45	100,11	975	9.565	0,00	180,00	6,61